

Reassemble the LINK II

Flip the base over, taking the twist out of the ribbon cable going to the front panel board. Slide the base into the front flange, aligning the base and front. Install the three philips screws in the bottom front. Flip the LINK over and install the three screws in the cover.

Test Upgrade

If anything does not conform to this test procedure, immediately disconnect the power and call or email MSB for help. Plug power into the LINK II. The power light should come on. Apply a digital source. The source should be indicated with an LED and you should hear a small click. You should immediately hear audio from the analog outputs. As you turn the toggle switch on and off, music should be heard in either position.

HDCD Board Upgrade for LINK II

If your HDCD board was specified for installation in the LINK II, it may have been modified for you by MSB. Please verify that the following change was made. If it has not been modified, please make the following changes:

1. Remove resistor R5
2. Cut trace running from pin 15
3. Solder 1K resistor from the farthest side of trace cut to the pad of R5. (If you do not add this resistor, the only effect will be that the LED on the upgrade board will not light up when HDCD is detected.)

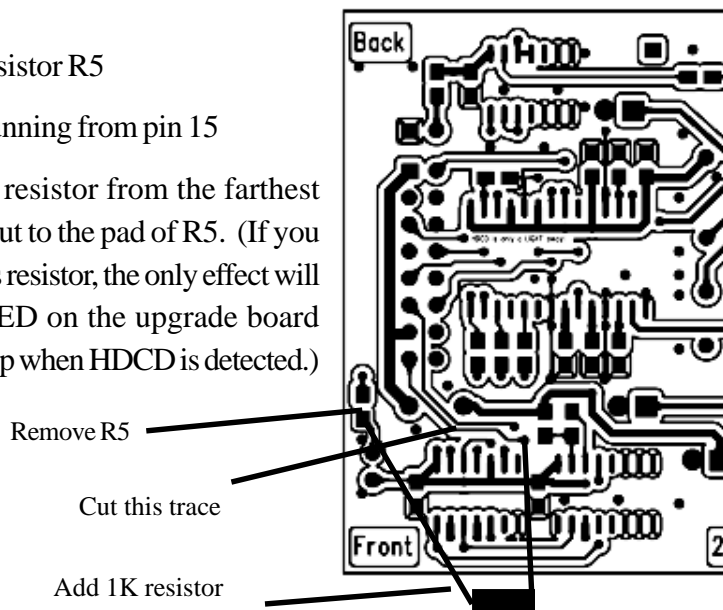

INSTALLATION OF THE HDCD AND UPSAMPLING UPGRADE FOR THE LINK DAC II



14251 PESCADERO RD. LA HONDA, CA 94020
(650) 747-0400 F. (650) 747-0405

WWW.MSBTECH.COM

INSTALLATION

This manual describes how to install an Upgrade in a LINK II.

LINK II Preparation

Place the LINK II on a soft surface like a tablecloth or carpet. Disconnect the power supply. Remove the three philips screws on the back edge of the cover. Turn the LINK over and remove the three philips screws from the front edge of the cover. Carefully separate the base from the cover. Pick up the base and flip it over, placing it inside the cover. Take care not to disconnect the ribbon cable to the front panel. Place the LINK so that the RCA connectors are facing AWAY from you. This way all the diagrams will be oriented correctly.

Upsampling Upgrade Installation

The upsampling board is not attached to any header, but is to be glued to the LINK board. Place it over U6 and U10 with the writing on the board oriented in the same way as the writing on the LINK II board. Silicon rubber is a good choice. Snip the left end of the cap C30 as close to the board as possible. Locate J18 on the upsampling board. Bridge pins 5 and 7 with solder as shown. Locate the connector J2

on the upsampling board. Run wires as follows:

- Pin 3 PCB pad under cut capacitor lead C30
- Pin 4 Cut pin on C30
- Pin 5 Reset test point on LINK board
- Pin 7 Pin 8 on U13
- Pin 9 Pin 16 of U13

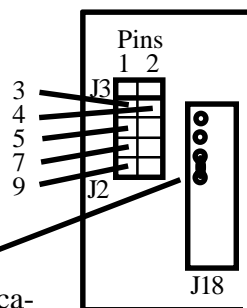

HDCD Upgrade Installation

Check the HDCD board for the LINK II modification (Page 4). Remove the jumpers from J14 Option Header. Plug HDCD board (J14 DAC Option) into J14. Apply glue under the other connector to secure option board. Snip one side of R25 and R33 and lift clear of PCB. Run wires from HDCD header J16 as follows:

- Pin 2 Ground - top side of C45
- Pin 4 Right end of R22
- Pin 8 Ground - top side of C58
- Pin 10 Right end of R30

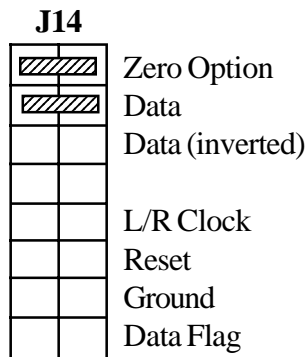

Switch Installation

On the back of the LINK III is a 1/4" hole with a plastic plug in it, next to the power connector. Remove the plastic plug. Install the switch in the hole oriented as shown. The connector can be oriented either way in J3. If both upgrades are being installed, modify the wiring of the switch as shown below, to share one toggle switch. Another option is to just use the

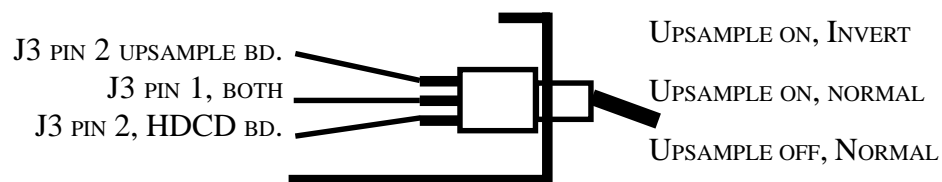
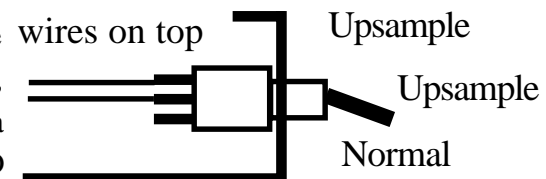
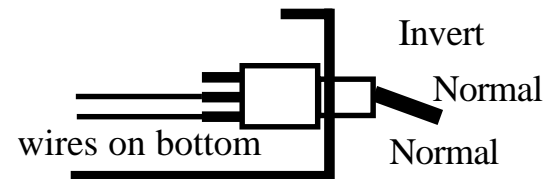

SWITCH WIRING WITH BOTH UPGRADES

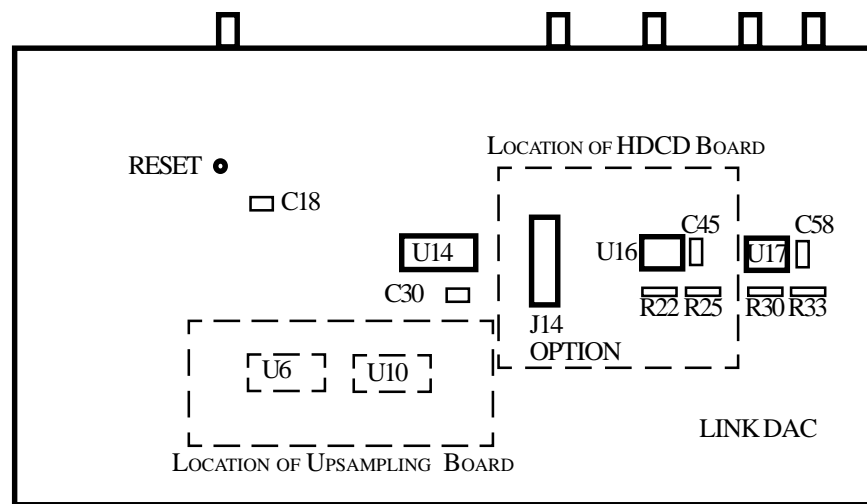

LOCATION OF ALL POINTS FOR WIRE ATTACHMENT